

# 2J6041PGFa

CELLULAR/LTE MIMO and GNSS Adhesive Mount

## Key Features

### Cable 1 - 2: CELLULAR / LTE

- 698-960 MHz
- 1710-2170 MHz
- 2500-2700 MHz

### Cable 3: GPS/GLONASS/QZSS/Galileo

- 1575-1606 MHz

Adhesive Mount

Ground Plane Independent

Customizable Cable and Connector

Dimensions: 80 x 76 x 16 mm



## 1. Antenna and electrical specifications

Cable 1

Parameters	CELLULAR / LTE Antenna		
<b>Standards</b>	2G,3G and 4G		
<b>Band (MHz)</b>	700/850/900	1700/1800/1900/2100	2600
<b>Frequency (MHz)</b>	698-960	1710-2170	2500-2700
<b>Return Loss (dB)</b>	~-9.7	~-21.5	~-8.8
<b>VSWR</b>	~2.2:1	~1.2:1	~2.2:1
<b>Efficiency (%)</b>	~55.6	~56.0	~38.7
<b>Peak Gain (dBi)</b>	~-2.9	~-3.2	~-2.1
<b>Average Gain (dB)</b>	~-2.6	~-2.5	~-4.1
<b>Impedance (Ohm)</b>	50		
<b>Polarisation</b>	Linear		
<b>Radiation Pattern</b>	Omni-Directional		
<b>Max. Input Power (W)</b>	25		
<b>Connector Type</b>	SMA-Male Standard (Other Connectors Available)		
<b>Cable Length</b>	300 cm Standard (Any Cable Length Available)		
<b>Cable Type</b>	LL100 Standard (Other Cables Available)		

Cable 2

Parameters	CELLULAR / LTE Antenna		
<b>Standards</b>	2G,3G and 4G		
<b>Band (MHz)</b>	700/850/900	1700/1800/1900/2100	2600
<b>Frequency (MHz)</b>	698-960	1710-2170	2500-2700
<b>Return Loss (dB)</b>	~-9.3	~-20.8	~-10.0
<b>VSWR</b>	~2.3:1	~1.2:1	~2.0:1
<b>Efficiency (%)</b>	~50.5	~53.9	~41.2
<b>Peak Gain (dBi)</b>	~-2.7	~-3.5	~-2.2
<b>Average Gain (dB)</b>	~-3.0	~-2.7	~-3.9
<b>Impedance (Ohm)</b>	50		
<b>Polarisation</b>	Linear		
<b>Radiation Pattern</b>	Omni-Directional		
<b>Max. Input Power (W)</b>	25		
<b>Connector Type</b>	SMA-Male Standard (Other Connectors Available)		
<b>Cable Length</b>	300 cm Standard (Any Cable Length Available)		
<b>Cable Type</b>	LL100 Standard (Other Cables Available)		

**Antenna Measurement Conditions:**

Mounted on 30 x 30 x 0.25 cm ABS Plate

200 cm of Cable LL100

Measured in Certified CTIA 3D Anechoic Chamber

Cable 3

Parameters	GPS/GLONASS Antenna	
	GPS/QZSS/Galileo	GLONASS
<b>Standard</b>		
<b>Band (MHz)</b>	1575	1602
<b>Frequency(MHz)</b>	1575.42	1598-1606
<b>Patch Size (mm)</b>	25 x 25 x 4	
<b>Return Loss (dB)</b>	<=-15.0 dB	
<b>VSWR</b>	<=1.4:1 dB	
<b>Impedance</b>	50	
<b>Radiation Pattern</b>	Hemispherical	
<b>Polarization</b>	RHCP	
<b>Saw Filter</b>	Pre-filter	
<b>Active Gain (dB)</b>	28 @ 2.7 V	
<b>Noise Figure (dB)</b>	1.5 Typ	
<b>Voltage (V)</b>	1.5 – 3.6	
<b>Current (mA)</b>	9 Typ	
<b>Power Consumption (mW)</b>	24.3 Typ	
<b>ESD Protection (kV)</b>	2kV	
<b>Connector Type</b>	SMA-Male Standard (Other Connectors Available)	
<b>Cable Length</b>	300 cm Standard (Any Cable Length Available)	
<b>Cable Type</b>	LL100 Standard (Other Cables Available)	

## 2. Mechanical and environmental specifications

Specifications	2J6041PGFa
<b>Mounting Type</b>	Adhesive Mount
<b>Dimensions (mm)</b>	80 x 76 x 16
<b>Radome Type</b>	ASA
<b>Radome Color</b>	Black or White
<b>Operating Temperature (C)</b>	-40 to +85
<b>Storage Temperature (C)</b>	-40 to +85
<b>Substance Compliance</b>	RoHS

## 3. Antenna parameters

Cable 1: CELLULAR/LTE

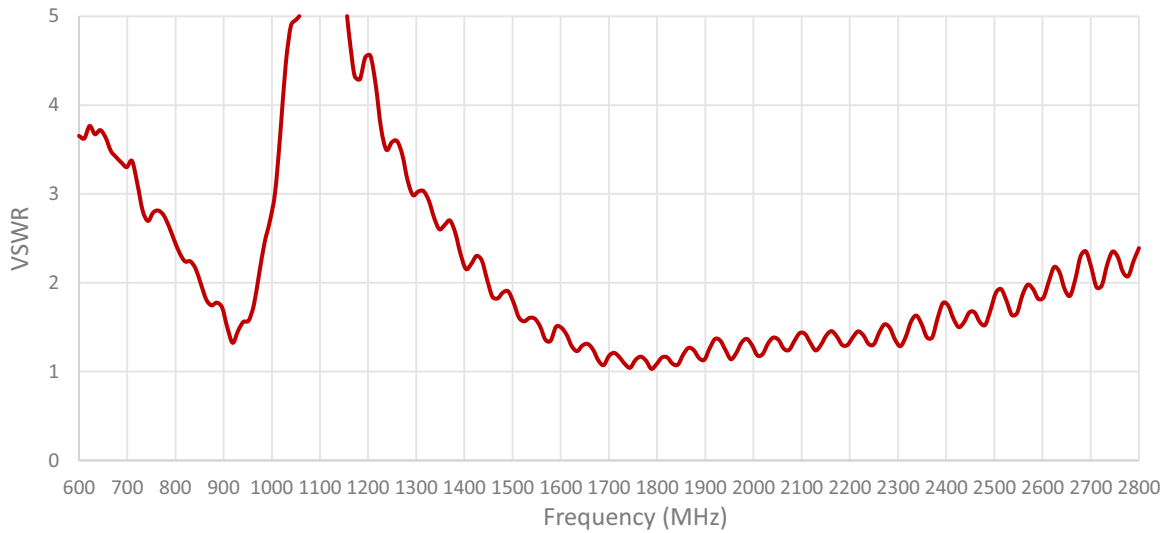
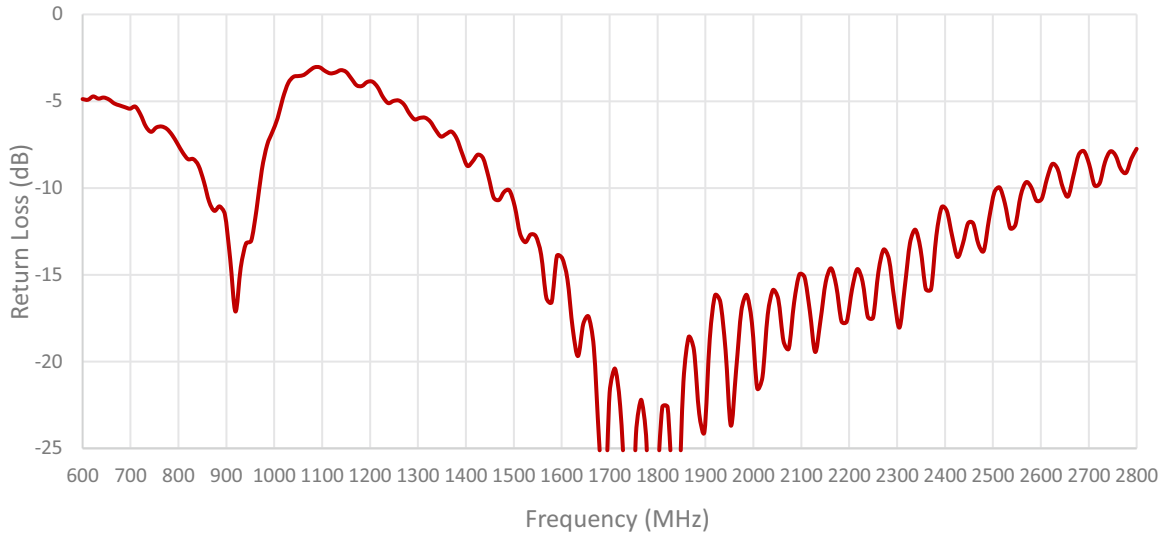

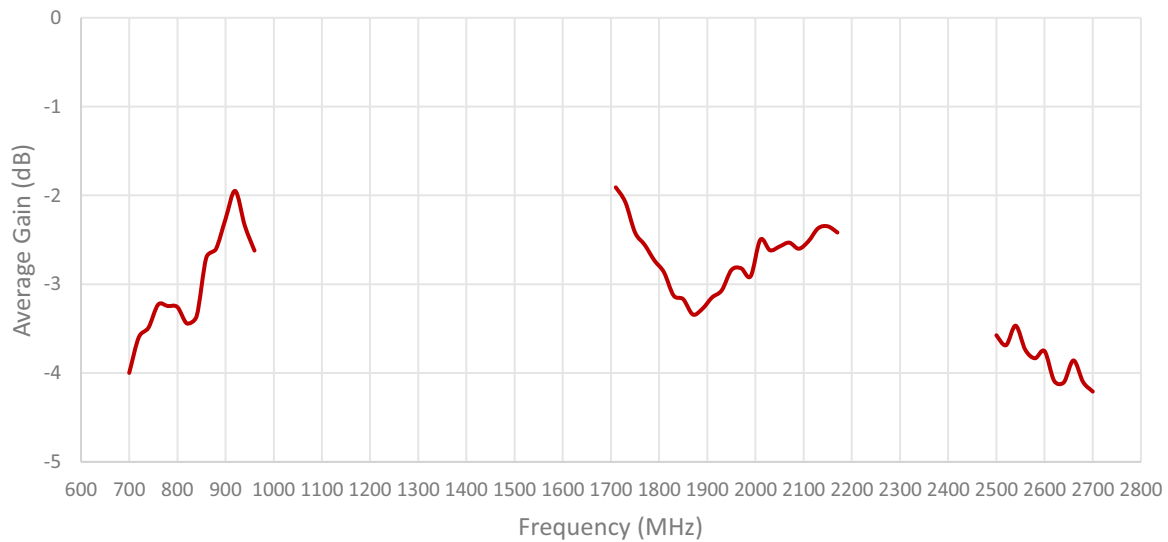
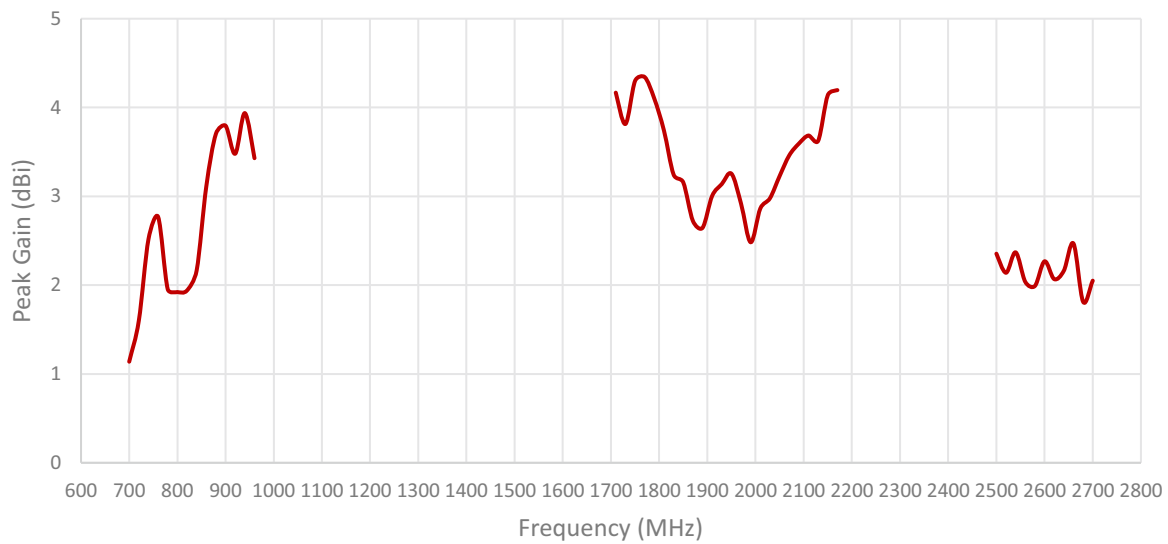
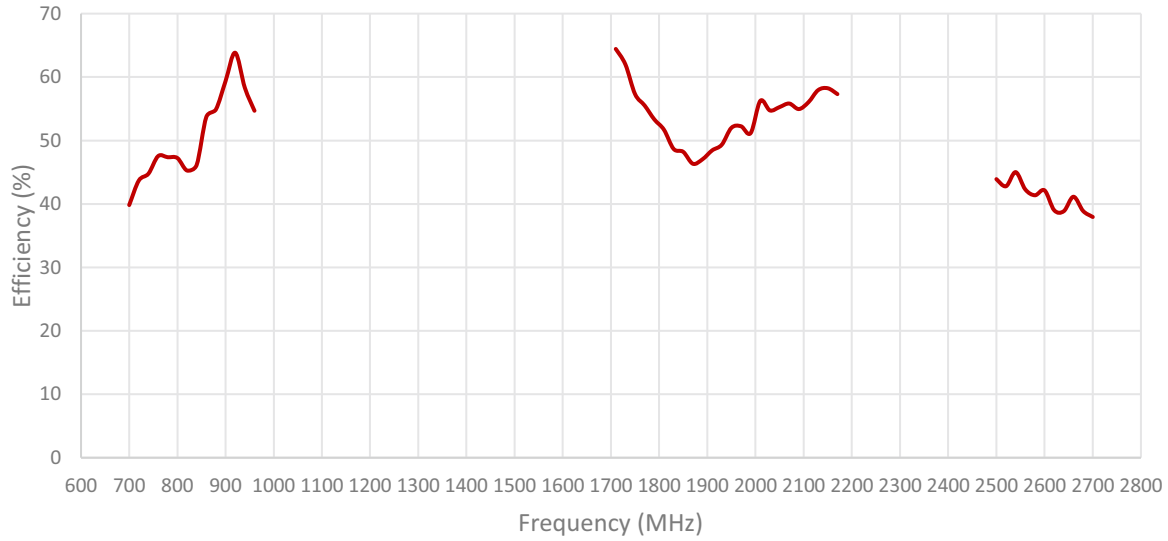

Cable 2: CELLULAR/LTE

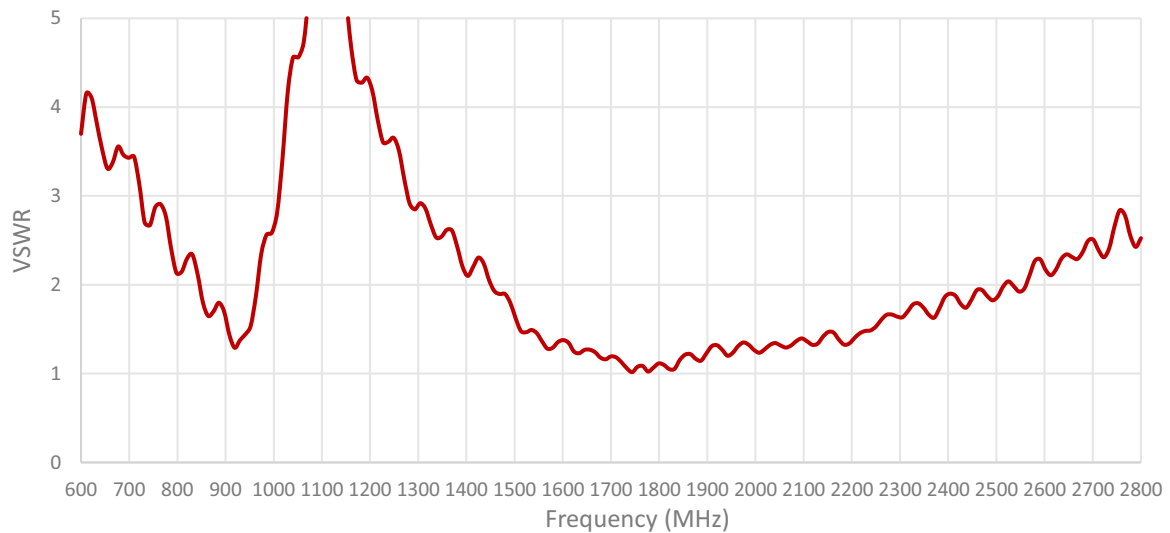
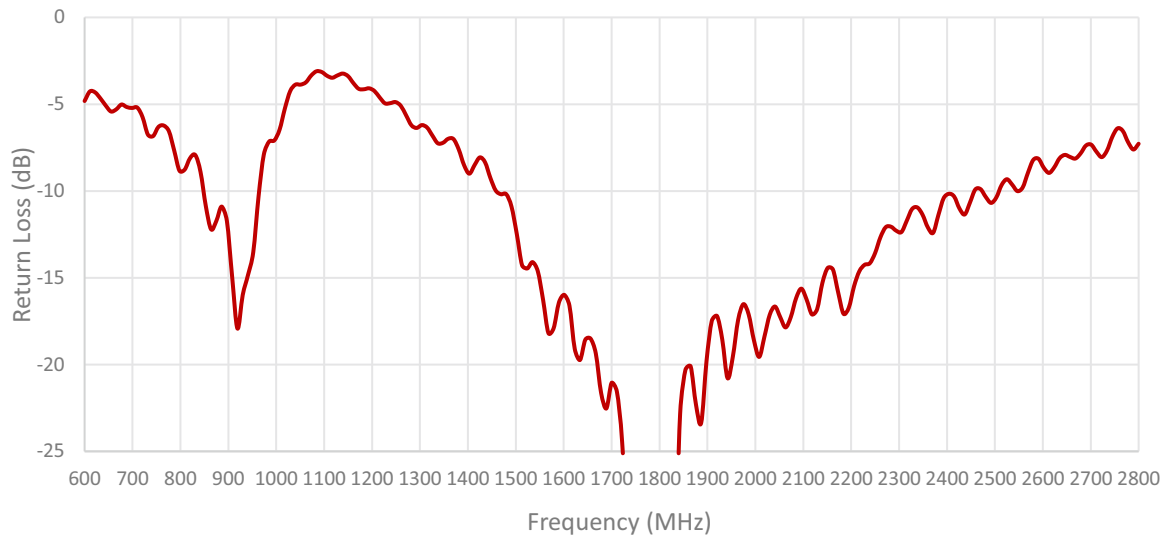

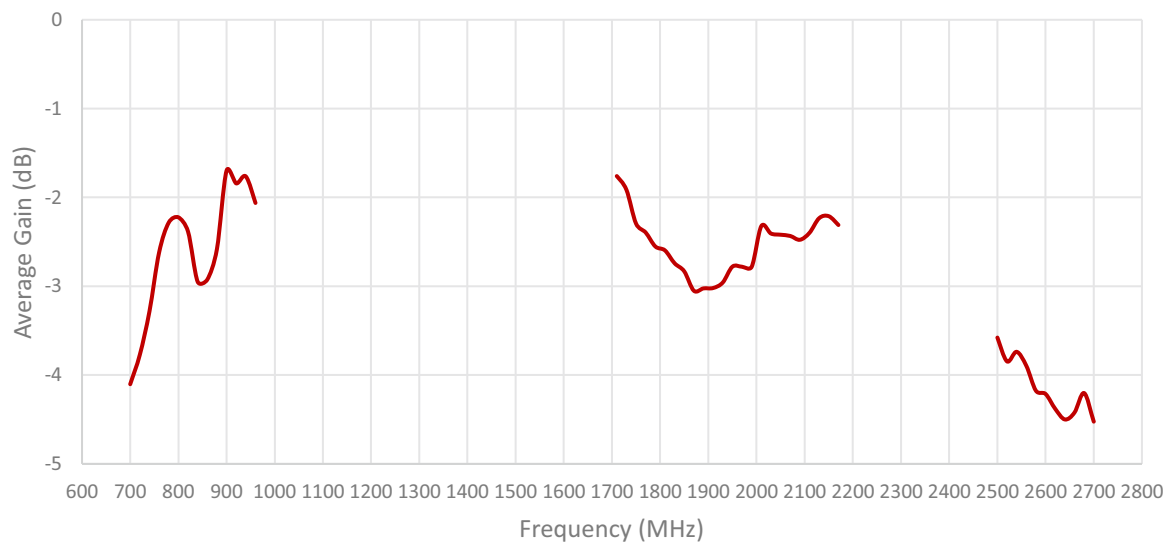
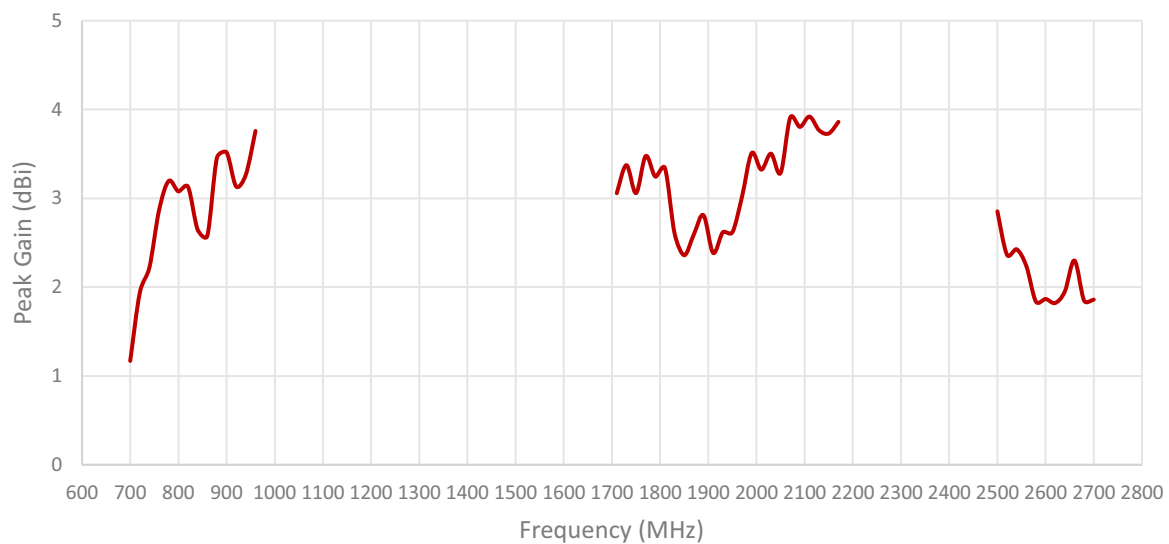
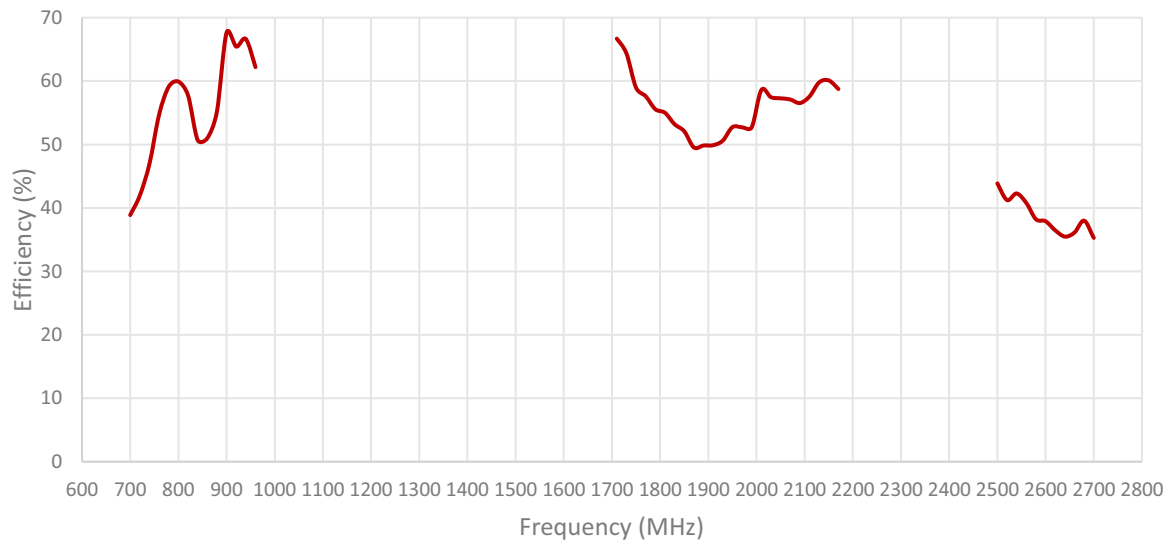

## ISOLATION FOR CABLES 1 AND 2

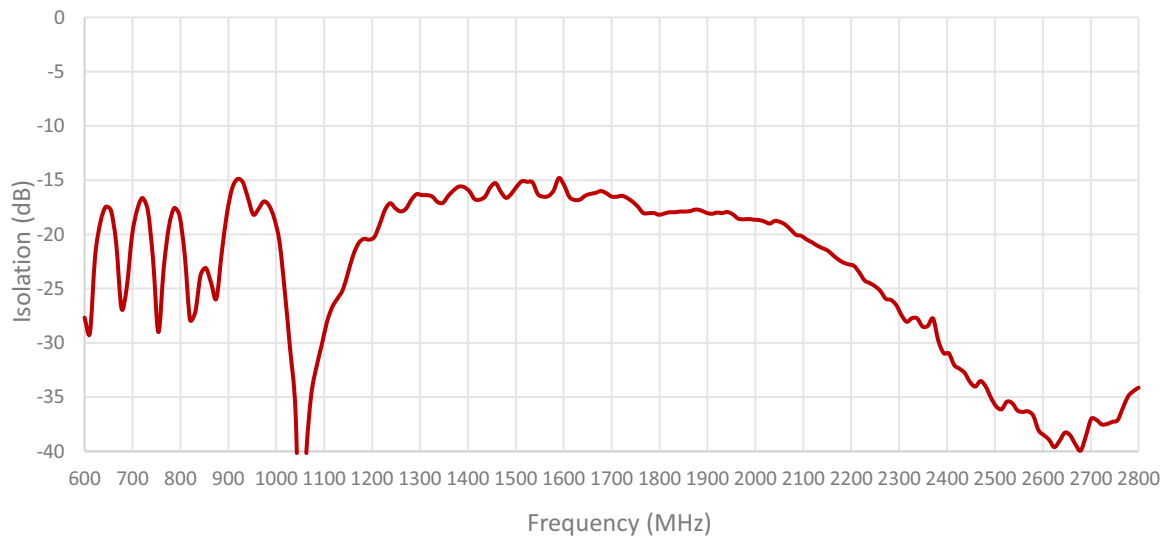

## ENVELOPE CORRELATION COEFFICIENT FOR CABLES 1 AND 2

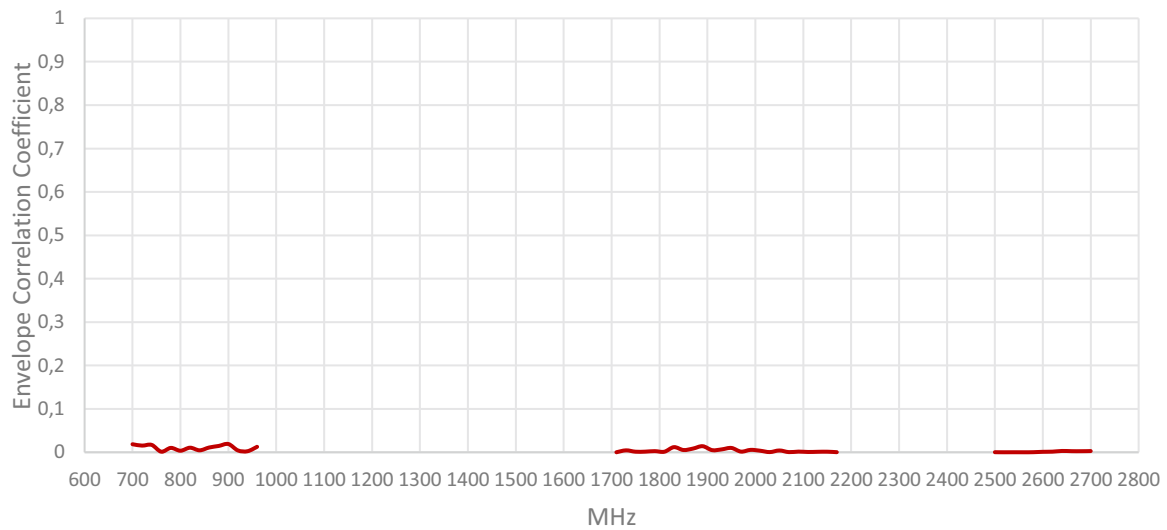

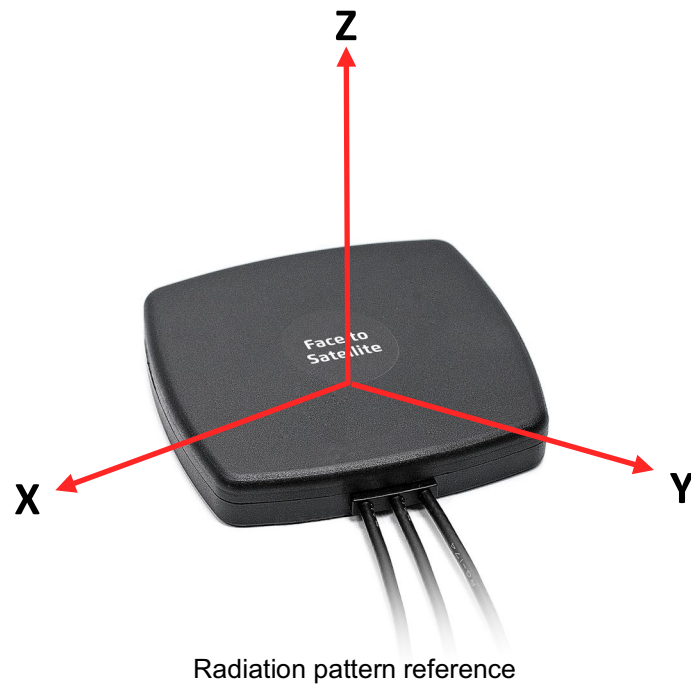

Cable 1: CELLULAR/LTE

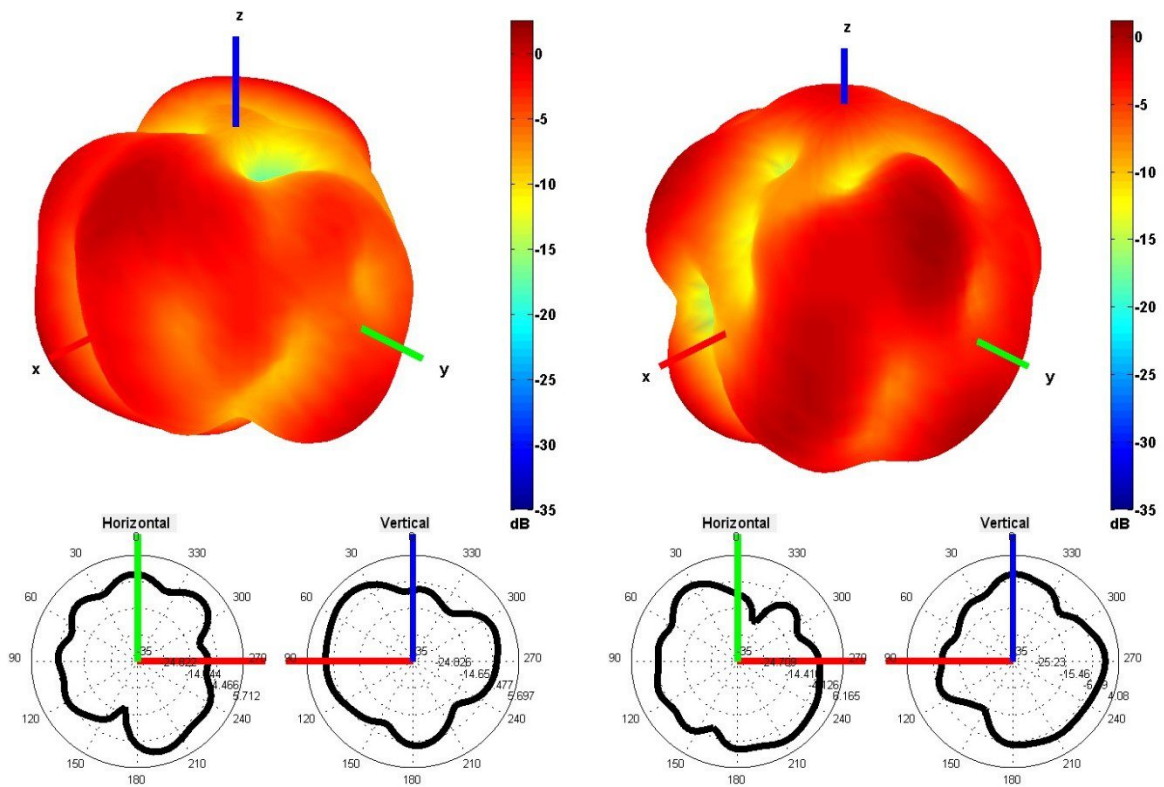

750 and 850 MHz Radiation pattern

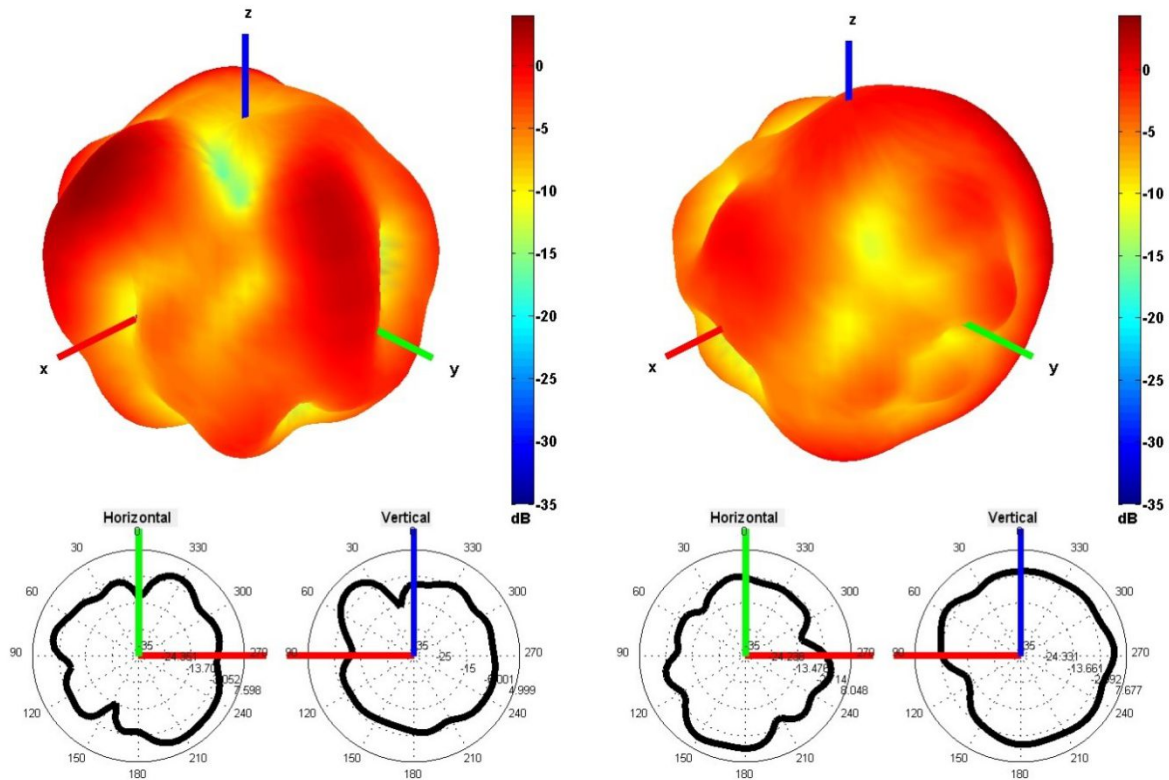

940 and 1750 MHz Radiation pattern

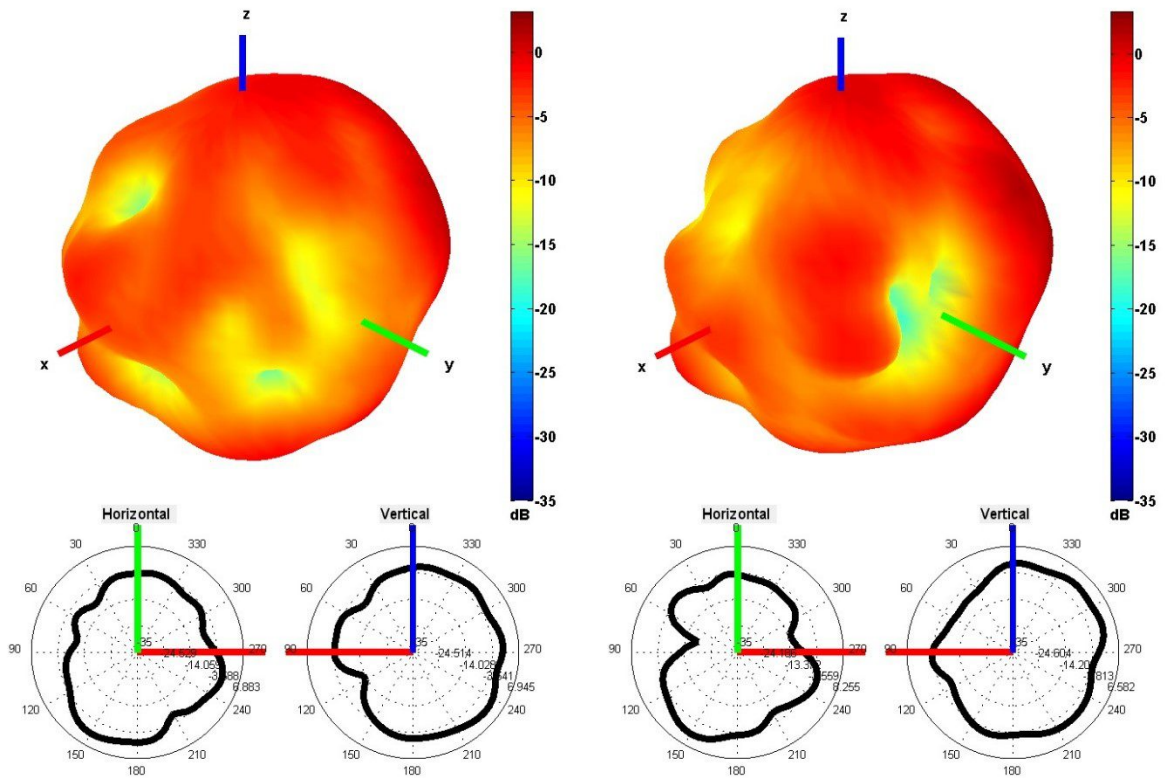

1850 and 1950 MHz Radiation pattern

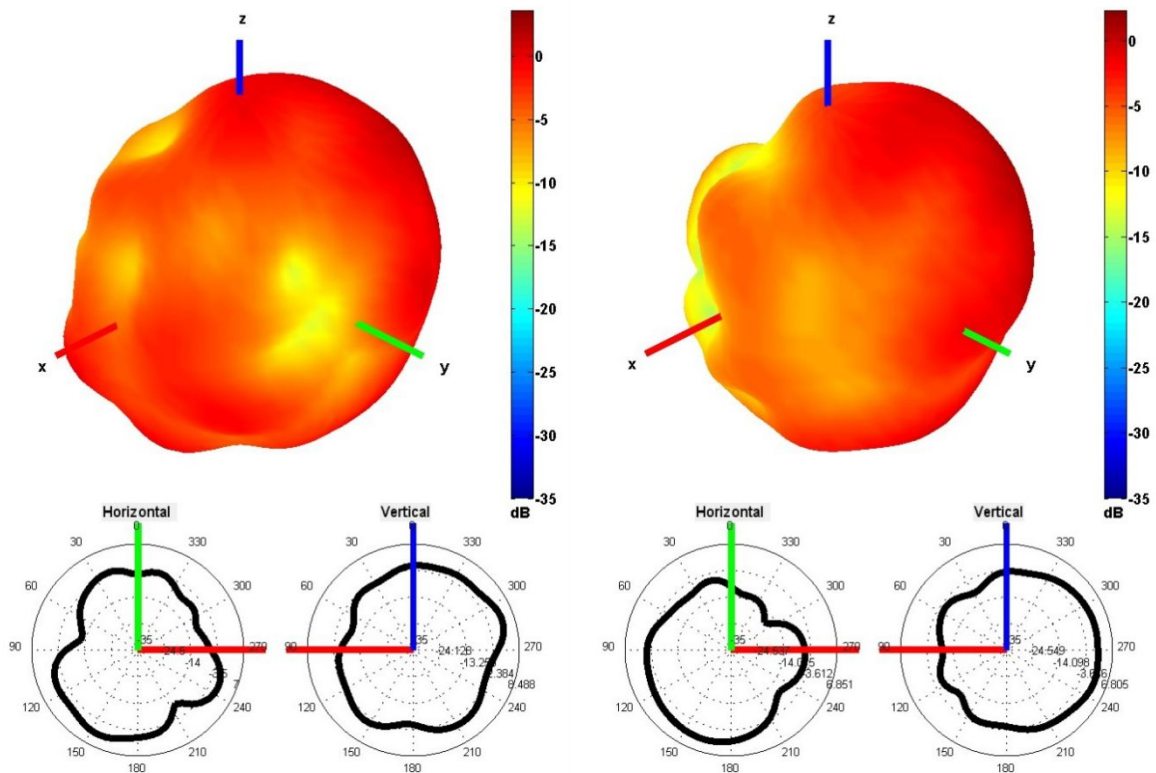

2100 and 2600 MHz Radiation pattern

Table 2: CELLULAR/LTE

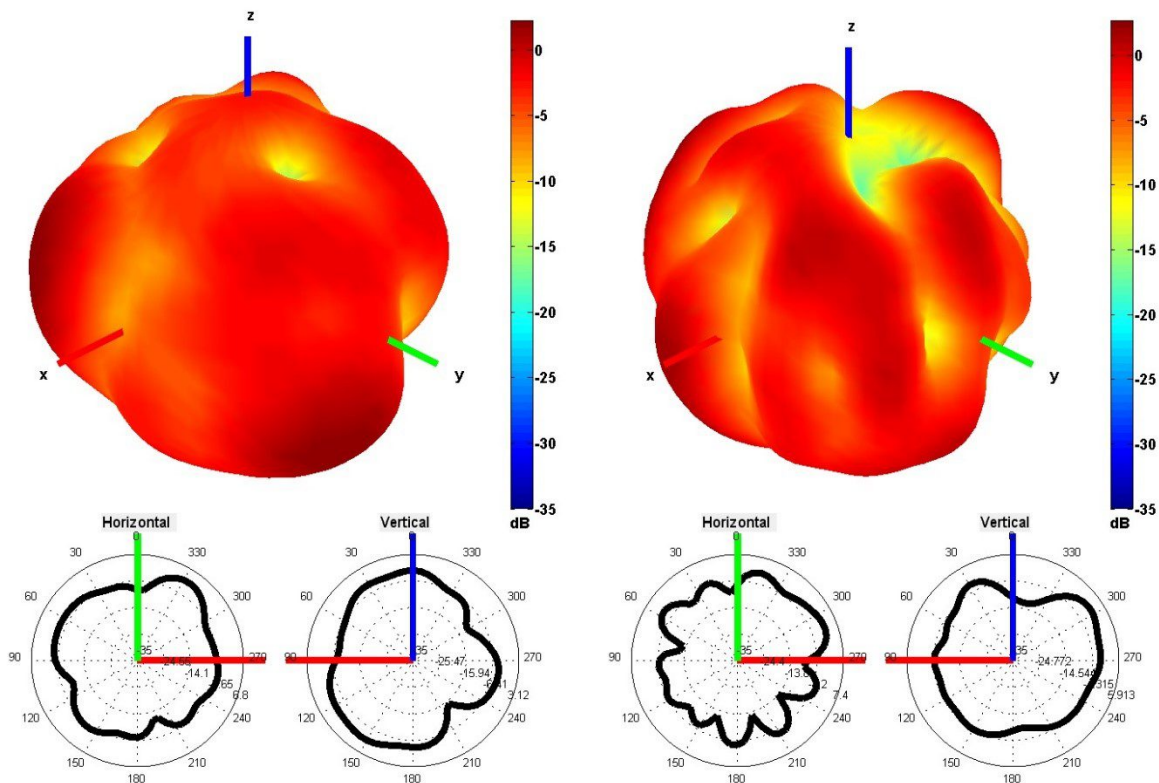

750 and 850 MHz Radiation pattern

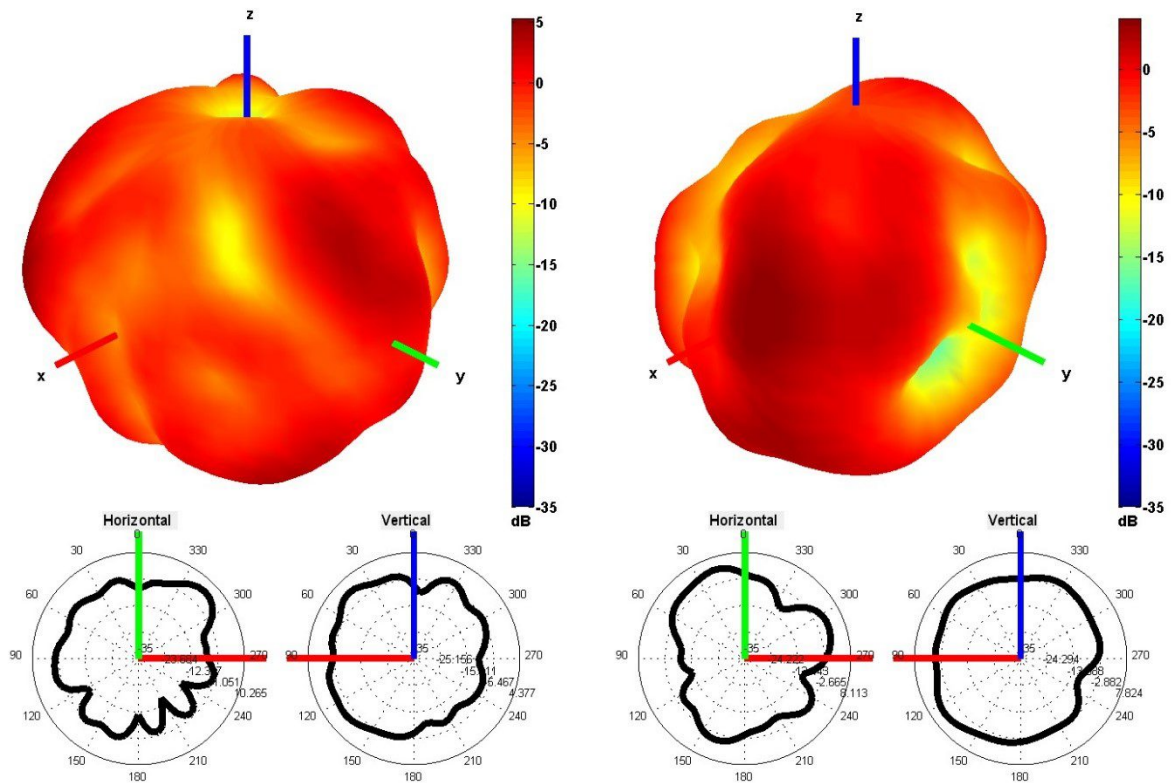

940 and 1750 MHz Radiation pattern

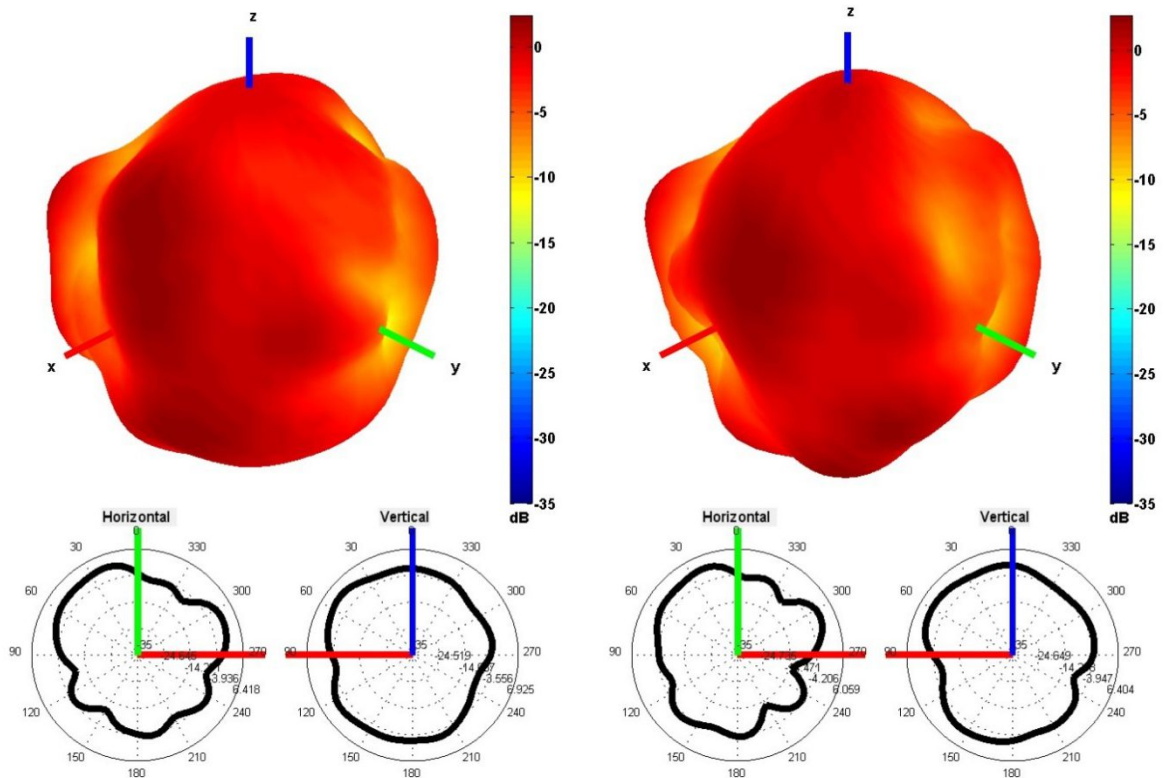

1850 and 1950 MHz Radiation pattern

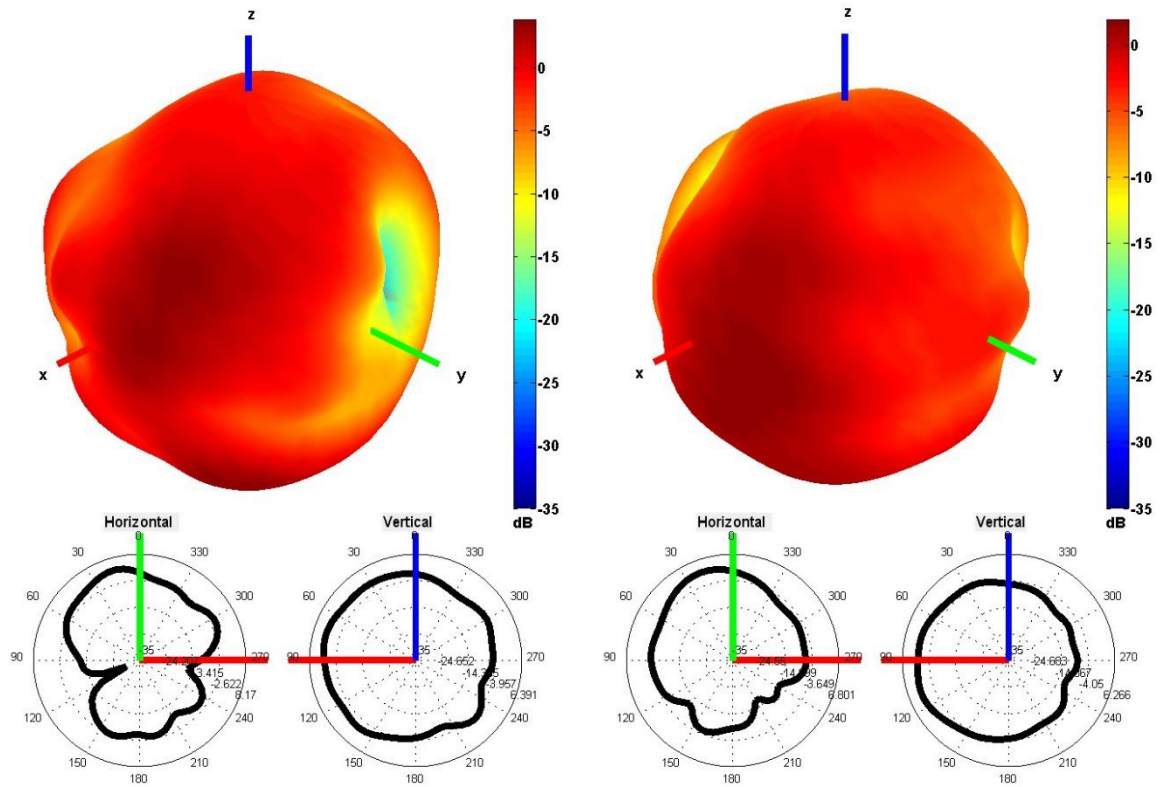

2100 and 2600 MHz Radiation pattern

## 4. Antenna drawings

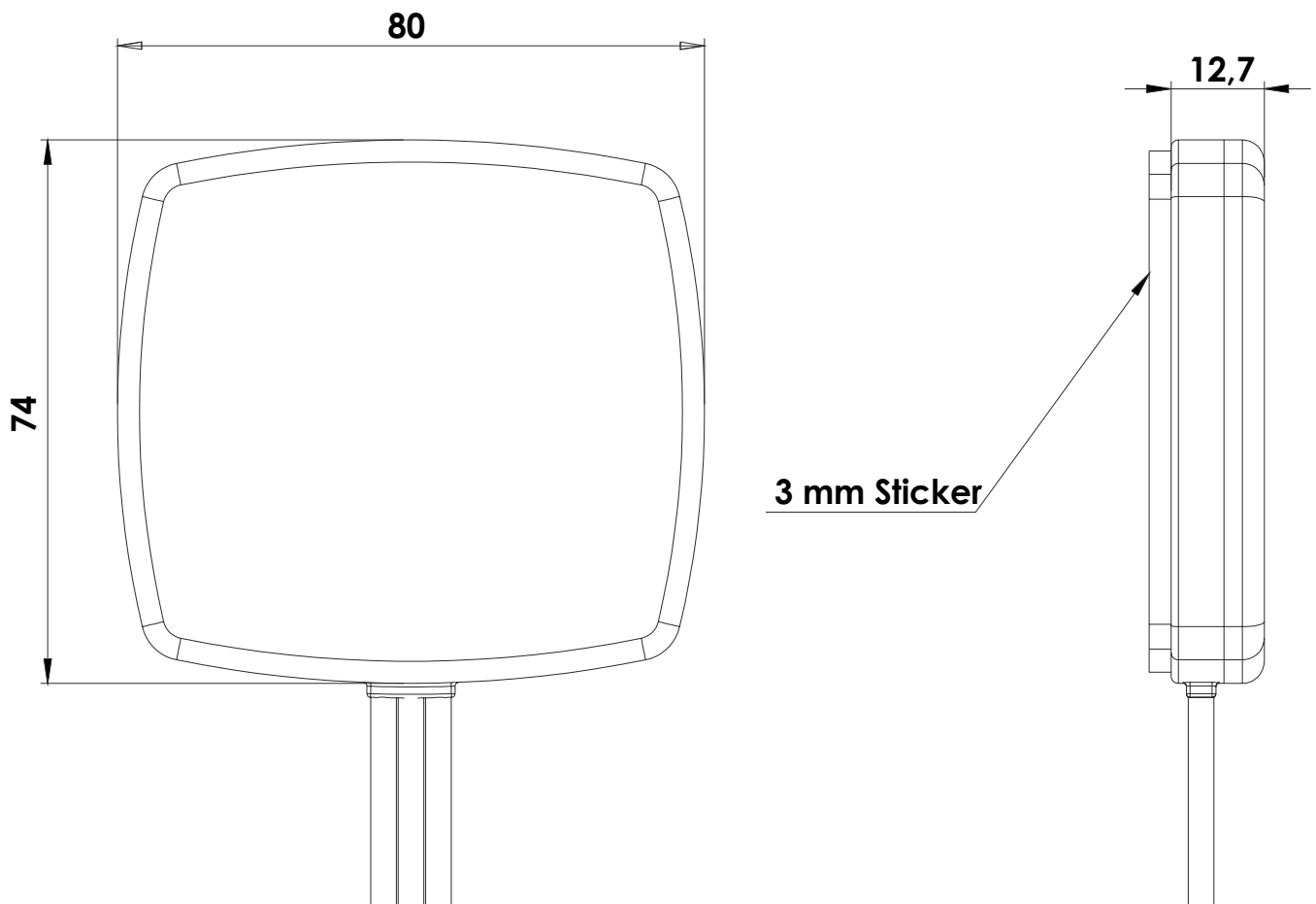

## 5. Antenna Images

