

2JW0915-915-C952B

915 MHz ISM Connector Mount

Key Features

915 MHz ISM
- 902-928 MHz
Connector Mount
High Performance
High Gain
Ground Plane Independent
Hinged Connector
Dimensions 170 × 18 × 10 mm



1. Antenna and electrical specifications

Parameters	915 MHz ISM Antenna
Standards	ZigBee, ISM, SIGFOX, LoRa
Band (MHz)	915 MHz
Frequency (MHz)	902-928
Return Loss (dB)	~-21.7
VSWR	~1.2:1
Efficiency (%)	~80.0
Peak Gain (dBi)	~3.8
Average Gain (dB)	~-1.0
Impedance (Ohm)	50
Polarisation	Linear
Radiation Pattern	Omni-Directional
Max. Input Power (W)	25
Connector Type	SMA-Male Standard

Antenna Measurement Conditions:

Free Space

Measured in Certified CTIA 3D Anechoic Chamber

2. Mechanical and environmental specifications

Specifications	2JW0915-915-C952B
Mounting Type	Connector Mount
Dimensions (mm)	170 × 18 × 10
Radome	ASA
Radome color	Black
Connector Feature	Hinged
Operating Temperature (C)	-40 to +85
Storage Temperature (C)	-40 to +85
Substance Compliance	RoHS

3. Antenna parameters

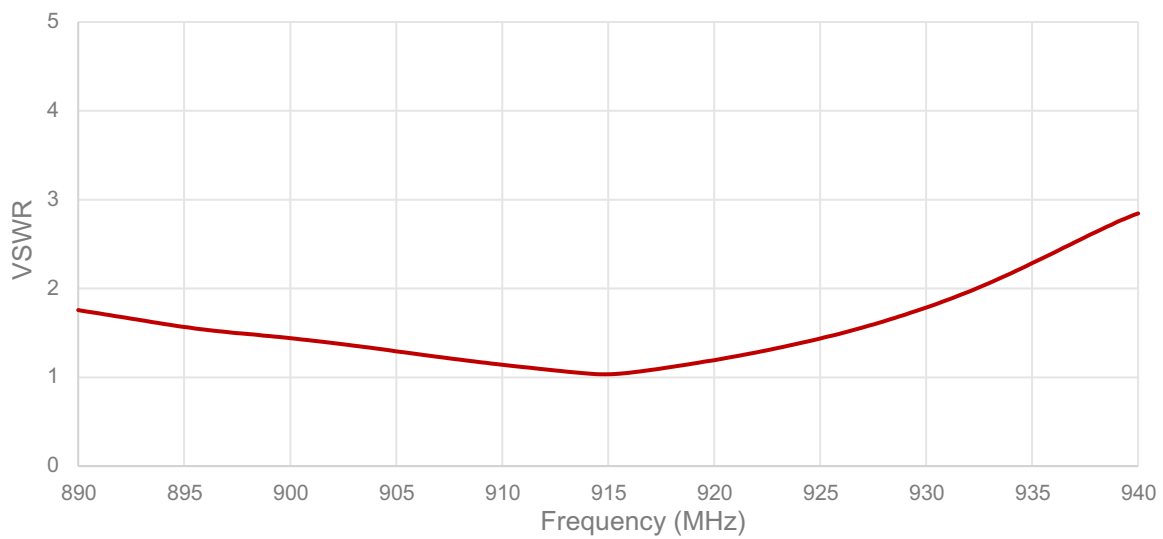
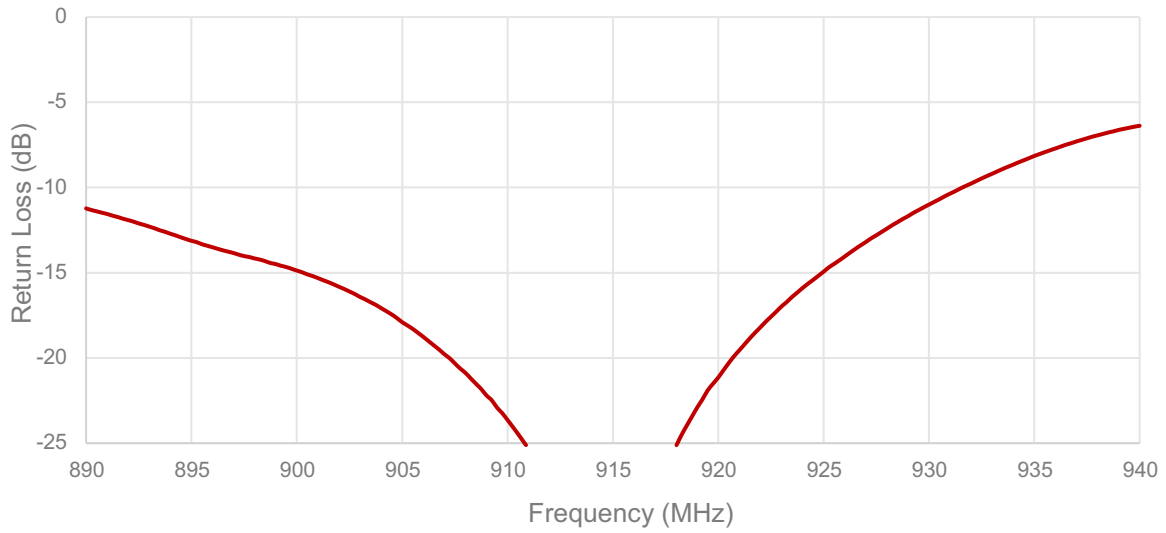

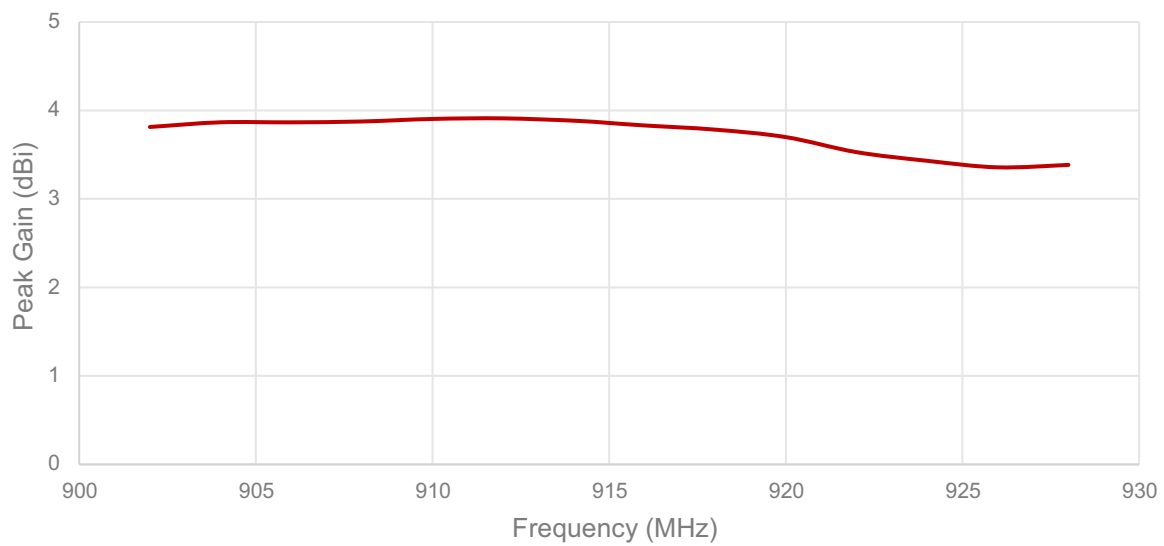
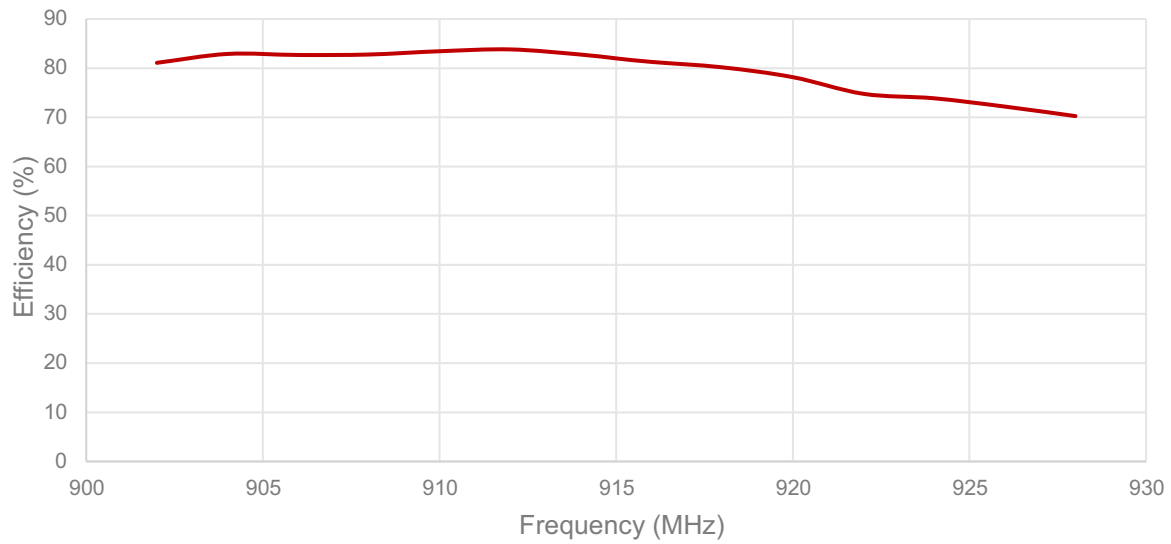

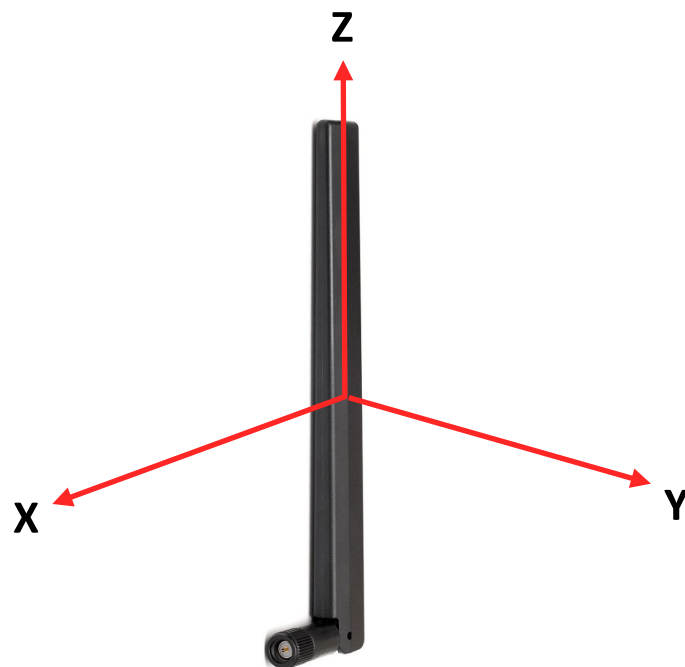
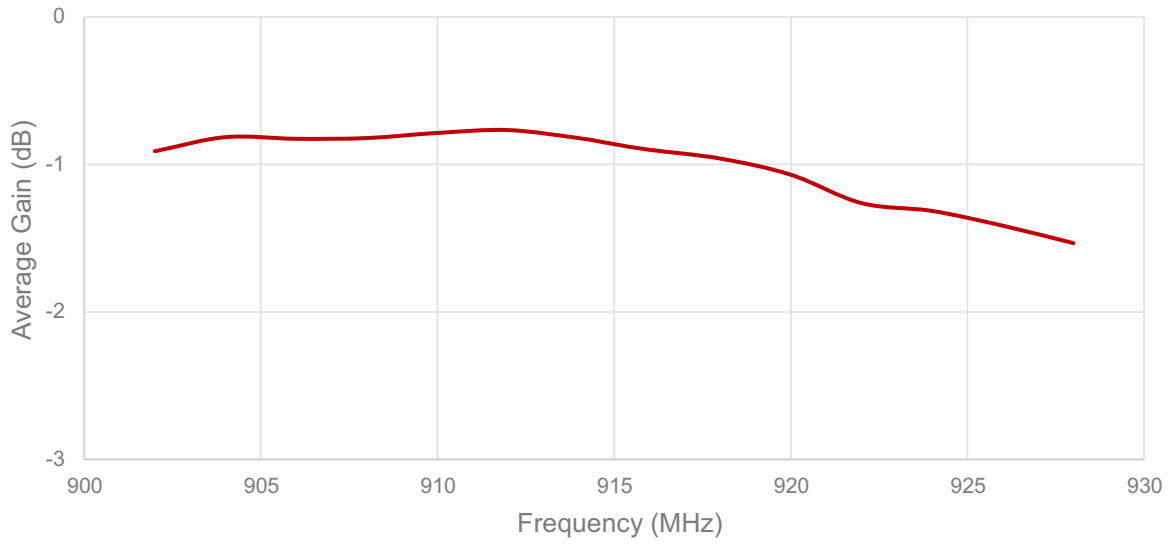

Radiation pattern reference

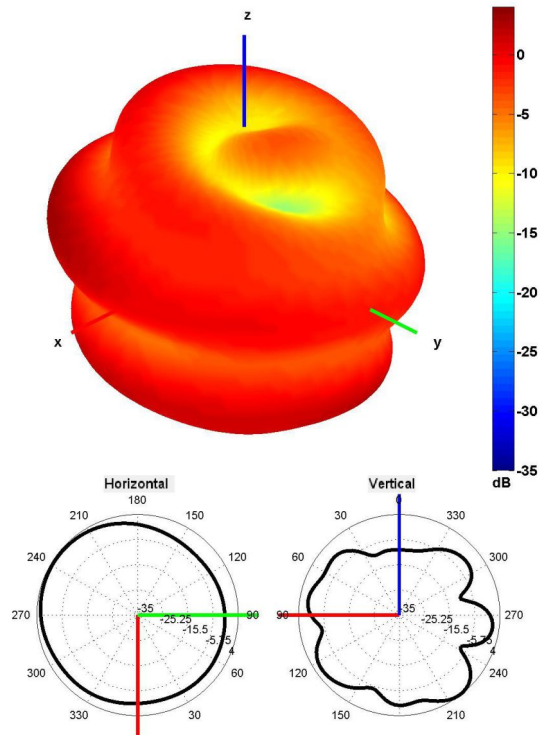

915 MHz Radiation pattern

4. Antenna drawings

Right Angle position

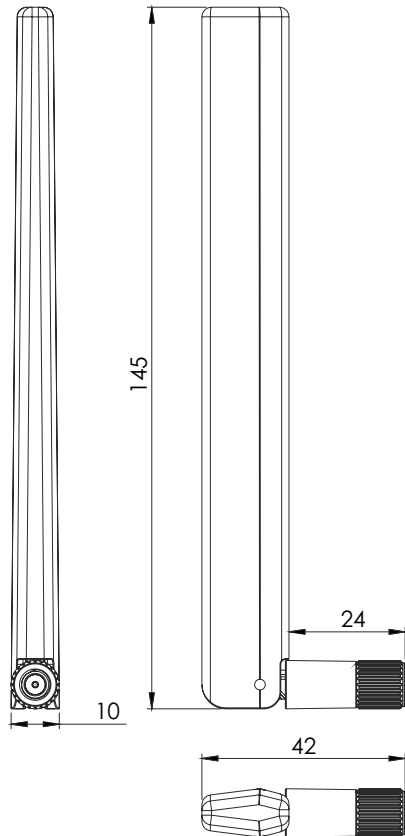

Straight position

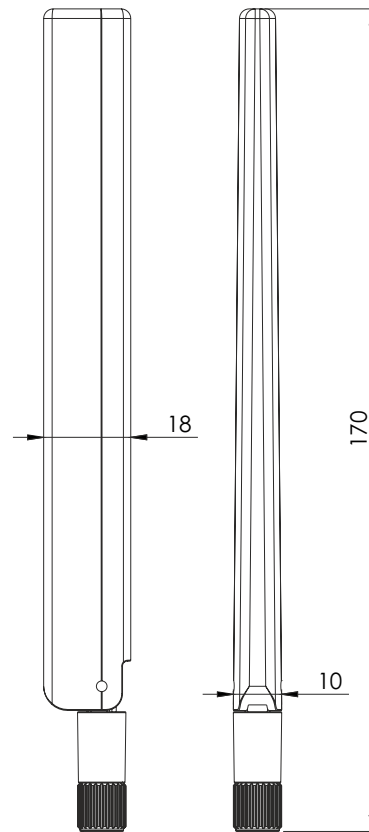

45° Angle position

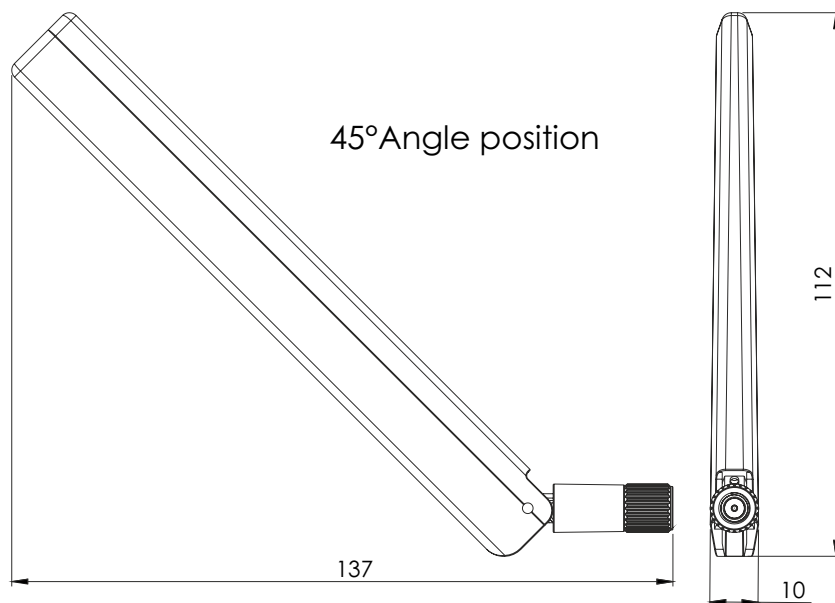

5. Antenna Images

