

2J3724M

CELLULAR / EU LTE only Magnetic Mount

Key Features

CELLULAR / LTE

- 791-960 MHz
- 1710-2170 MHz
- 2500-2700 MHz

Magnetic Mount

Low Profile

Ground Plane Dependent

Customizable Cable and Connector

Dimensions 30.9 x 71.5 mm



1. Antenna and electrical specifications

Parameters	CELLULAR / LTE Antenna		
	4G LTE/FirstNet/LPWA/CAT-X/CAT-Mx/CAT-NBx/NB-IoT/3G/2G		
Standards			
Band (MHz)	800/850/900	1700/1800/1900/2100	2600
Frequency (MHz)	791-960	1710-2170	2500-2700
Return Loss (dB)	~-11.3	~-8.5	~-4.7
VSWR	~2.0:1	~2.8:1	~3.9:1
Efficiency (%)	~59.6	~40.7	~20.8
Peak Gain (dBi)	~-2.1	~-0.5	~-1.4
Average Gain (dB)	~-2.4	~-4.1	~-6.8
Impedance (Ohm)	50		
Polarisation	Linear		
Radiation Pattern	Omni-Directional		
Max. Input Power (W)	25		
Connector Type	SMA-Male Standard (Other Connectors Available)		
Cable Length	300 cm Standard (Any Cable Length Available)		
Cable Type	LL100 Standard (Other Cables Available)		

Antenna Measurement Conditions:

Mounted on 30 x 30 cm Ground Plane

100 cm LL100 Cable Length

Measured in Certified CTIA 3D Anechoic Chamber

2. Mechanical and environmental specifications

Specifications	2J3724M
Mounting Type	Magnetic Mount
Dimensions (mm)	30.9 × 71.5
Radome	PC/ABS UV Stable
Radome color	Black
Operating Temperature (C)	-40 to +85
Storage Temperature (C)	-40 to +85
Substance Compliance	RoHS

3. Antenna parameters

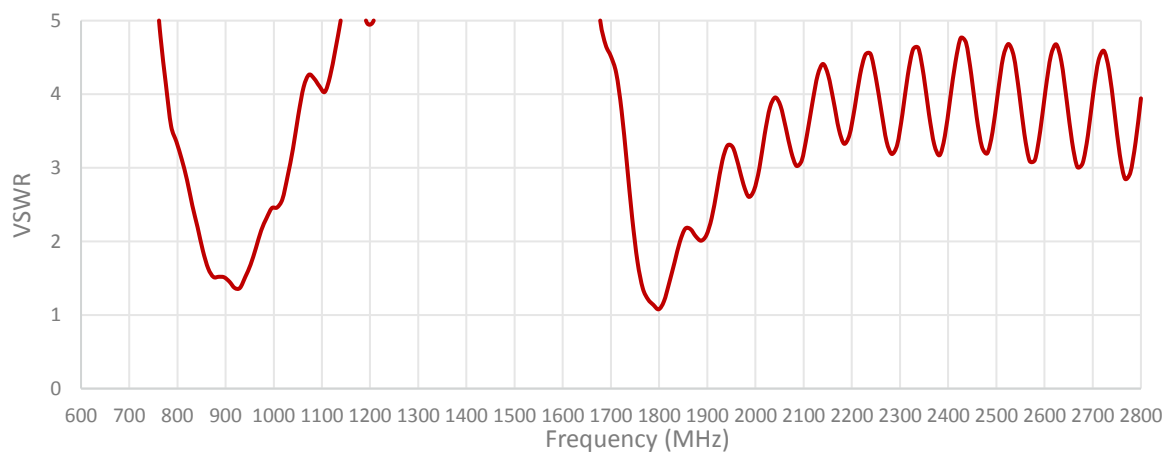
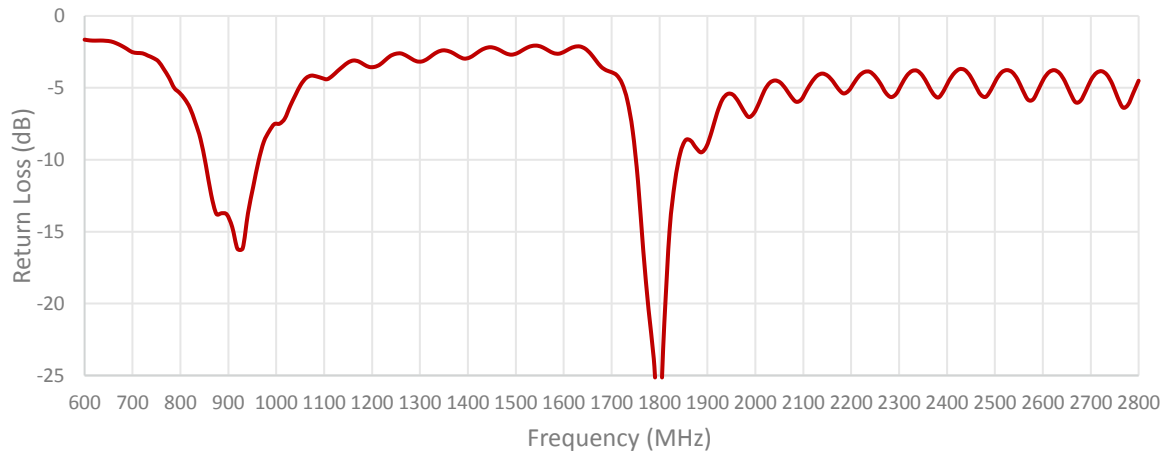

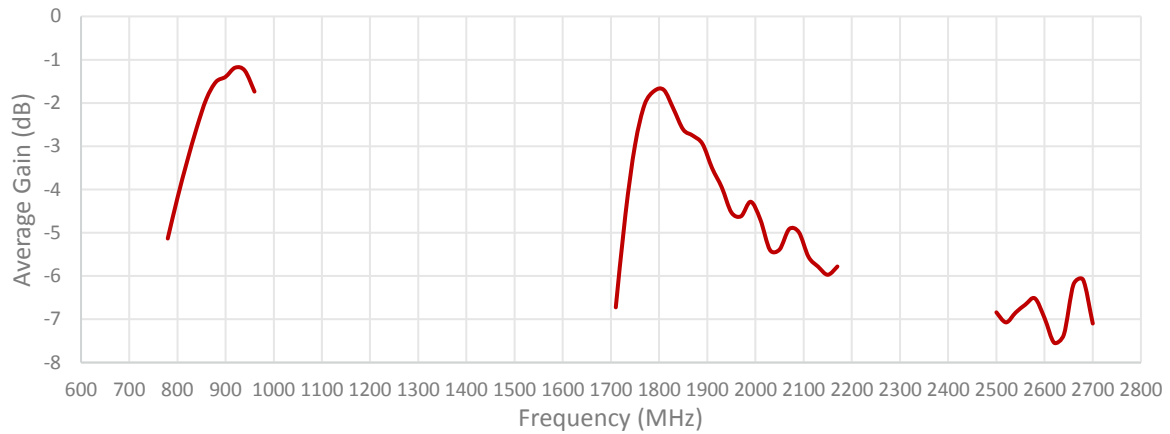
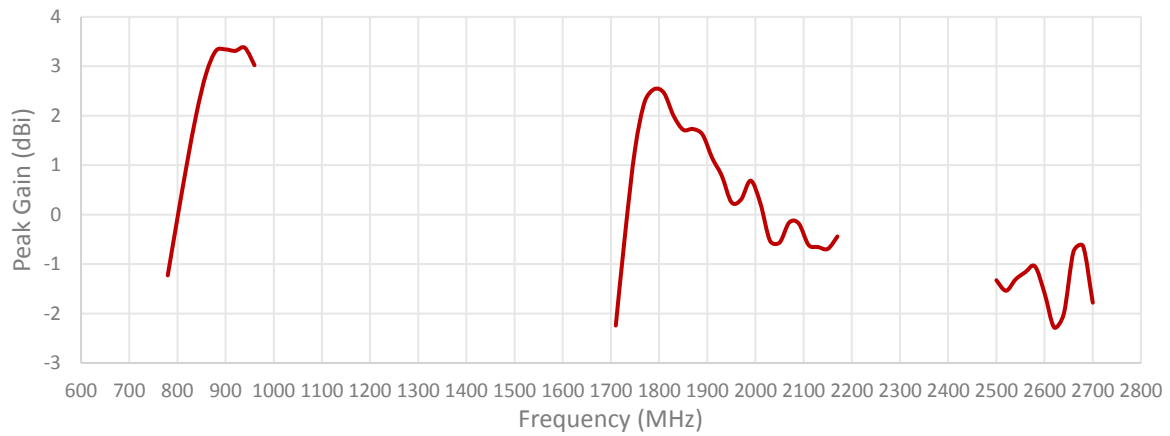
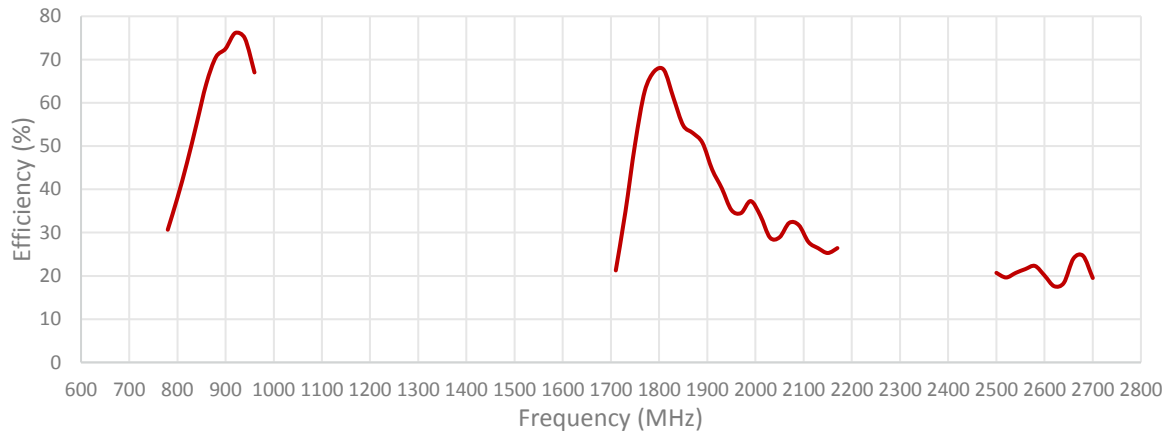

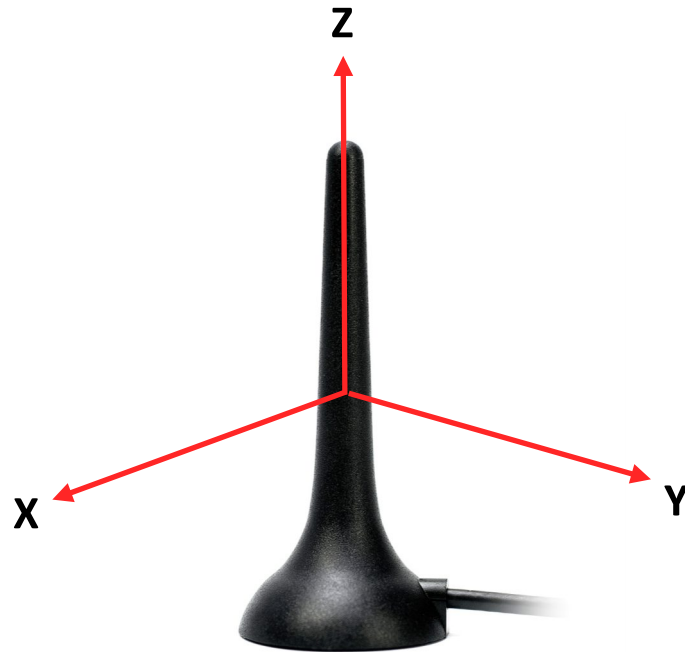

Radiation pattern reference

CELLULAR/LTE

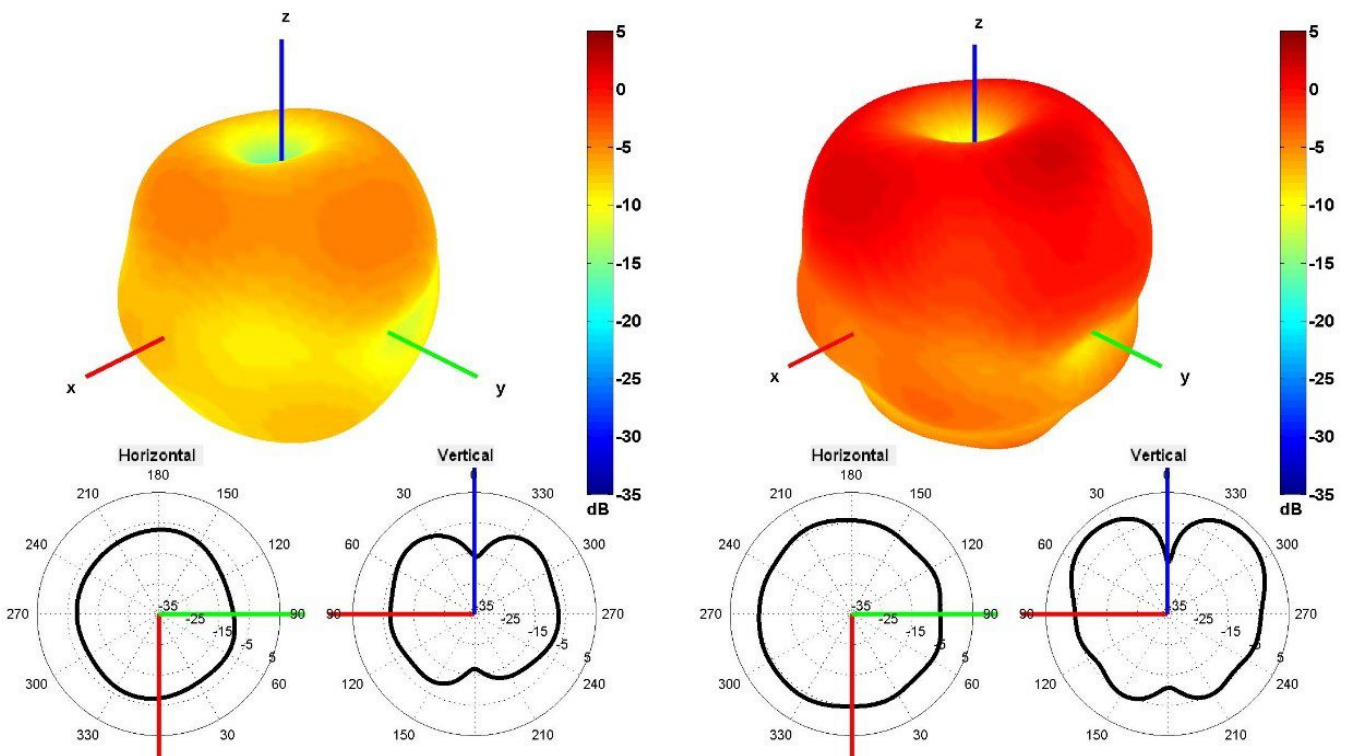

750 and 850 MHz Radiation pattern

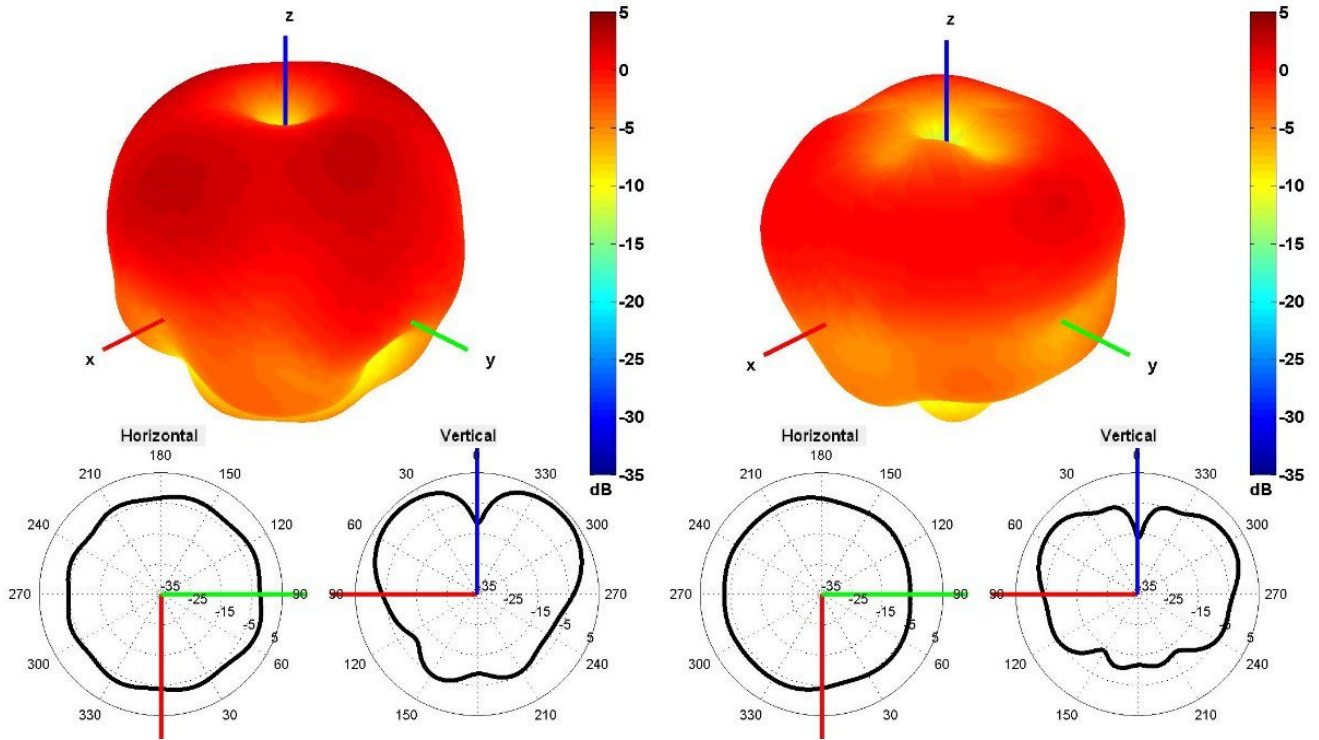

940 and 1750 MHz Radiation pattern

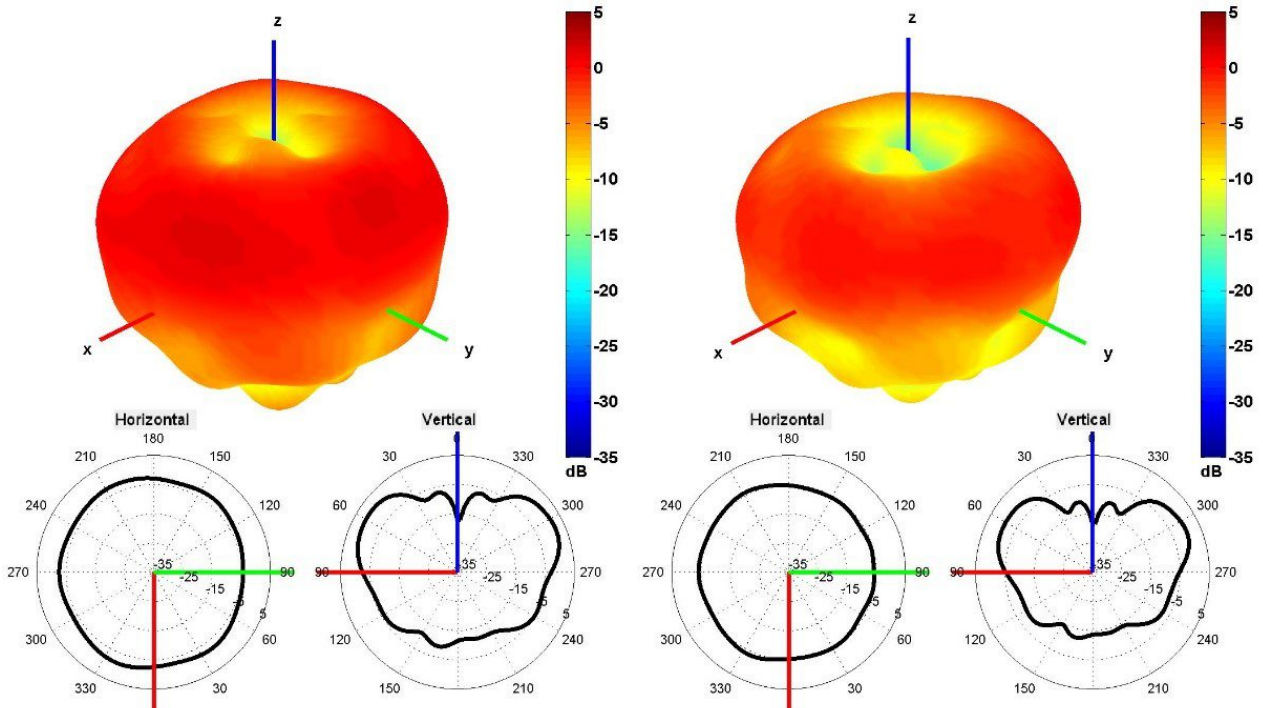

1850 and 1950 MHz Radiation pattern

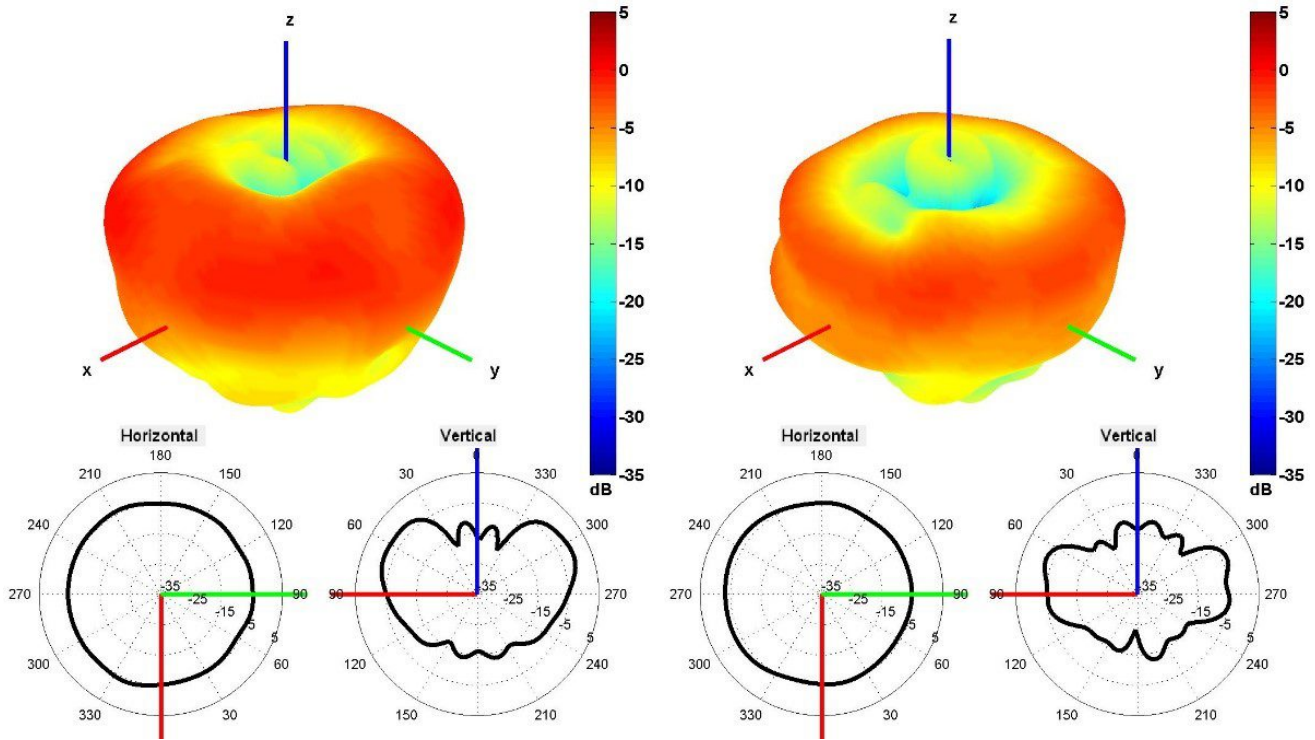

2100 and 2600 MHz Radiation pattern

4. Antenna drawings

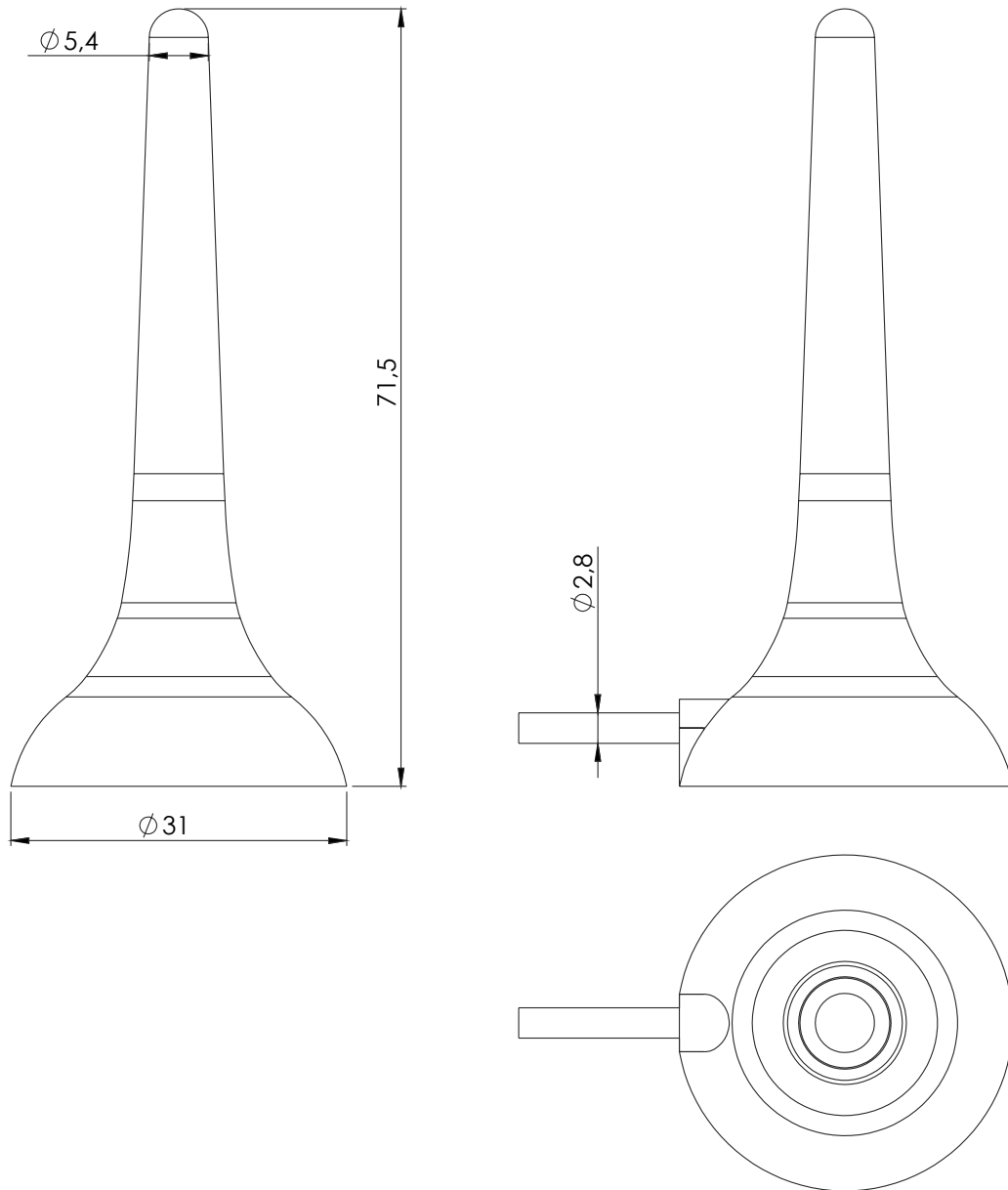

5. Antenna Images

